

# Phoenix™ Dry Heat Systems

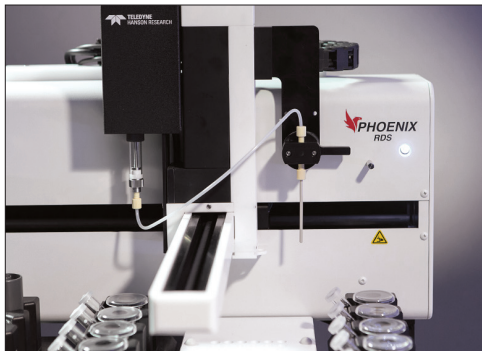

## PRODUCT SELECTION GUIDE

# PHOENIX DRY HEAT SYSTEMS OVERVIEW

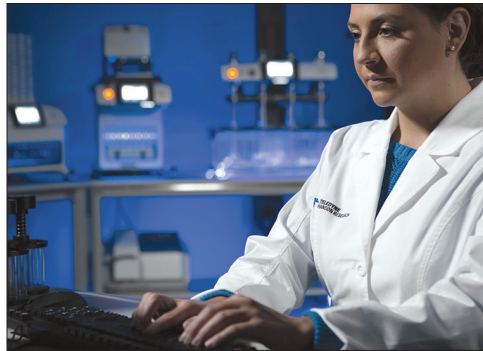

Teledyne Hanson has released a line of diffusion testing products entitled Phoenix™ Dry Heat Systems. The Phoenix family includes an advanced diffusion cell design, a six-cell manual sampling system (Phoenix DB-6), and a 6 or 12 cell automated sampling and collection platform (Phoenix RDS).

## Phoenix Diffusion Cells

The Phoenix™ Diffusion Cell provides improved ease of use, high durability, and greater versatility as compared to conventional hand-blown vertical diffusion cells. Phoenix cells operate on dry heat; no water-jacketing is required, allowing construction from heavy-duty borosilicate glass held to very tight dimensional tolerances. The extract-and-replace sampling through the



large diameter opening in the sampling arm accommodates standard pipette tips (~300  $\mu$ L), simplifying the sampling process while reducing training and operating costs.

## Powerful Mixing

Special grooves machined into the tops and sides of the mixer-inserts provide strong circulation and nearly instantaneous homogenization of cell contents. This system prevents the formation of regions of higher concentration of API under the membrane, thereby reducing test variability.

## Test Preparation

Phoenix cells are quick to set up. Dosage forms are applied to an easily accessible opening in the cell cap. No clamps are required. Bubbles are easily detected and removed simply by lifting the cell and tipping it to one side.

## Chemical Compatibility

The Phoenix press-on style of cell cap is made from polyether ether ketone (PEEK), sealed with O-rings made from Viton™ (fluoroelastomer). The Phoenix threaded style of cell cap is made from polytetrafluoroethylene (PTFE), sealed with O-rings made from either Viton or Kalrez™ (perfluoroelastomer) for higher compatibility with aggressive solvents such as THF and DMSO.

## Serialized Components

As each diffusion cell, mixer, and cell cap has its own serial number, traceability and process control are improved.

# MANUAL AND AUTOMATED SAMPLING PLATFORMS

## Broad Range of Test Parameters

With three sizes of diffusion cells, short and tall mixer-inserts for each, and a variety of cell cap designs and sizes, the Phoenix platform provides analysts with a broad range of diffusion cell testing capabilities. Receptor media volumes range from



Small, medium, and large diffusion cells with short or tall mixer-inserts.

10 mL to 30 mL, dosage volumes from 0.25 mL to 6.3 mL and orifice diameters 9 mm to 20 mm. For further details on the capabilities of each style of cell cap, see pages 13-15.

## Cell Caps Modular Design

The amount of API entering the receptor cell is directly related to the exposed surface area of the membrane, which depends on the orifice diameter



Cap kits include serialized cell caps and dosage chambers with precision orifice diameters.

of the dosage chamber. To ensure uniform and consistent membrane surface area exposure from one cell to the next, Phoenix cell caps are machined to very tight tolerances, thereby reducing one source of test results variability.

Phoenix Dry Heat Systems Range of Diffusion Cell Testing Parameters			
Phoenix Diffusion Cell Sizes	Receptor Media Volume*	Orifice Diameters	Dosage Chamber Volumes*
Small	10 mL	9 mm	0.25 mL to 2.0 mL
		11.3 mm	
	13 mL	9 mm	
		11.3 mm	
Medium	15 mL	11.3 mm	0.40 mL to 3.5 mL
		15 mm	
	21 mL	11.3 mm	
		15 mm	
Large	20 mL	15 mm	0.71 mL to 6.3 mL
		20 mm	
	30 mL	15 mm	
		20 mm	

\* Volumes shown are nominal; actual volumes will vary and are determined by measurement of each specific diffusion cell assembly in the lab.

## Build Your Own System

1. Choose manual sampling (pp. 4-5) or automated sampling (pp. 6-7).
2. Select one or more cell sizes (p. 9) based on the range of receptor media volumes needed for your intended applications.
3. Specify the appropriate mixers for the above sets of cell sizes (p. 11).
4. Select one or more types of cell cap kits based on the orifice diameters and dosage volumes appropriate to your expected range of experiments (pp. 12-15).
5. Choose transport/storage accessories (p. 16).
6. For assistance with product selection or service and validation options, contact your local Teledyne Hanson representative, or call the factory at +1 818-882-7266, or email us at [hansonsales@teledyne.com](mailto:hansonsales@teledyne.com).

# PHOENIX DRY HEAT SYSTEMS

## Phoenix DB-6 Manual Sampling System



The Phoenix DB-6 (six-cell diffusion block) provides an ideal platform compliant with 21 CFR Part 11 for release-rate testing of six vertical diffusion cells at once using manual sampling methods. Controlled by an advanced computerized display, the DB-6 provides uniform and precise heating and stirring of six cells. The compact footprint of the DB-6 economizes on lab bench space.

### Rapid and Precise Heating

Heating of the receptor media comes from the DB-6 dry heat block programmable from 25 °C to 45 °C with a stated accuracy of  $\pm 1.0$  °C, while actual performance is typically within  $\pm 0.3$  °C. With the dry heat approach, there is no longer any need for conventional water pumps, jacketed cells, and a network of tubing running into and out of each cell. Heat-up is fast. Starting at room temperature, the DB-6 block and its six diffusion cells typically reach the desired set point in 30 minutes or less.

### Powerful Mixing and Homogenization

An important advantage of the Phoenix DB-6 is the speed with which the receptor cell's contents are homogenized. A critical factor in diffusion cell testing for IVRT and IVPT applications is the uniformity of the receptor media. Any unmixed, high concentration of API dwelling directly under the membrane will slow the diffusion process,

affecting test results. The Phoenix system resolves this issue through custom-designed mixer-inserts inside each cell, driven by powerful brushless motors. The combination of grooved mixers and strong magnetic drives prevents the formation of diffusion-rate barriers directly under the membrane, thereby reducing variability of test results. Stirring speeds are programmable from 200 rpm to 900 rpm with an accuracy  $\pm 10\%$ .

### Bubble Detection and Removal

An air bubble trapped beneath the membrane in a vertical diffusion cell can be a source of release-rate variability. In the Phoenix system, bubble detection and removal is fast and easy. Bubbles are easily detected using a lighted mirror. When a bubble is found, the analyst simply lifts and tips the cell to move it out through the top of the sampling arm.

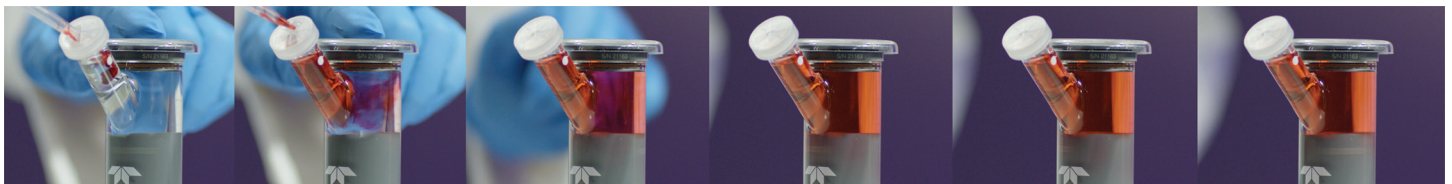

Visual testing of mixing effectiveness by dispersion of red dye placed on top of media in the sampling arm with images at 1 second intervals from 0 to 5 seconds while mixing at 400 rpm.

# PHOENIX DB-6 MANUAL SAMPLING SYSTEM

## Transition to Automation

Phoenix DB-6 blocks are designed to reduce costs when scaling up operations and transitioning from manual sampling methods to automated sampling using the Phoenix RDS platform. Each DB-6 block can be installed onto the Phoenix RDS robotic sampling platform without modification.

## Phoenix DB-6 Computer Control

The Phoenix DB-6 is controlled by an advanced single-board computer built into the color touch screen display. The Linux-based operating system with its own SQL database provides outstanding memory and processing speed.



Power and serial communications occur through a cable connecting the display to the DB-6 block. The tethered display can be hand-held or moved to any nearby location, while a magnetized back allows it to attach to the front or side of the DB-6.

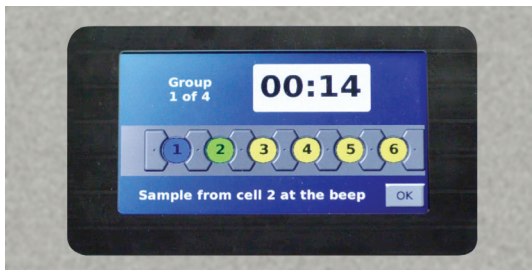

System reminds analyst of sampling time points with visual and audible alerts.

The highly durable resistive touch screen responds instantly and works with lab gloves on or off. The intuitive, user-friendly interface of the DB-6 replicates the familiar look and feel of Hanson's proven line of Vision G2 instruments. During a test an easy-to-read screen displays temperature, stirring speed, elapsed time, and time to next sample. As a sampling point approaches, the system provides an audible alert and a countdown.

## Phoenix DB-6 Supply Kit

Each Phoenix DB-6 instrument comes with start-up supplies including 14 evaporation caps, 14 stoppers, and one each of disposable syringe (20 mL), tweezers, dosage mixer, stainless steel lab spatula, bubble inspection mirror, and plastic o-ring tool.

## 21 CFR Part 11 Compliance

Support for 21 CFR Part 11 compliance includes a self-calibrating speed control; built-in diagnostics with instant on-screen alert; auditable logs for events, errors, test reports, test history, and service; serial number tracking of eight different elements (six of each element); real-time clock; serial printer connection; security settings for up to 50 users or administrator profiles; inactivity timeouts; and incorrect login lockout.

## Phoenix DB-6 System Specifications

- Weight (dry): 4.22 kg (9.3 lbs.)
- Dimensions:
  - Heater and stirring block: 36.8 cm W x 7.6 cm D x 14.0 cm H
  - Display: 12.7 cm W x 2.2 cm D x 2.2 cm D x 7.2 cm H
- USP <1724> conformance:
  - Stirring speed  $\pm 10\%$
  - Temperature  $\pm 1.0\text{ }^{\circ}\text{C}$
- Heating block programmable from 25  $^{\circ}\text{C}$  to 45  $^{\circ}\text{C}$ .
- Power consumption: 80 watts max.

## ORDERING INFORMATION - PHOENIX DB-6 MANUAL SAMPLING SYSTEM

### PHOENIX DB-6 DIFFUSION TESTING SYSTEMS

**59-201-101** Phoenix DB-6 Manual Diffusion System 115/230V

System includes diffusion block, color display, and supply kit. Order cells, mixers, and cap kits separately.

### ACCESSORIES

**74-107-090** Printer, Validation, 115/230 V, Epson

### Q-PAK™ QUALIFICATION GUIDELINES

**59-208-110** Q-Pak Validation Guideline for Phoenix DB-6

## Phoenix RDS Robotic Diffusion Station

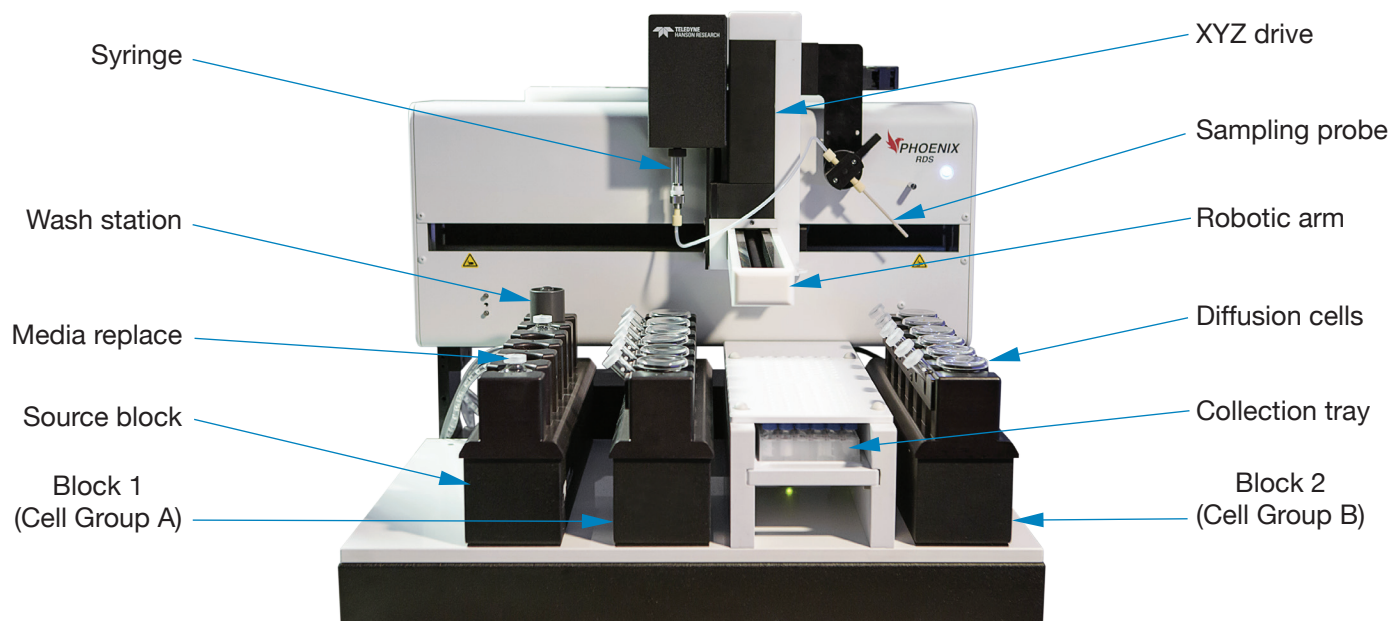

The Phoenix RDS platform provides fully automated sampling and collection for either six or twelve vertical diffusion cells in a compact footprint, using the same heating and stirring blocks as are found in the DB-6. A third block holds a wash station and up to five additional media sources. Samples are collected into 12x32 vials with pre-slit septa. Controlled by Teledyne Hanson's Diffusion Master™ software, up to two RDS systems (24 vertical diffusion cells at once) can be operated independently from a single computer workstation.

### Rapid Sampling and Collection

Automated sampling using an angled probe simulates manual methods. The sample is withdrawn, collected, and then media is replaced.



Volumetric accuracy meets or exceeds  $\pm 1\%$  or 25  $\mu\text{L}$ . Staggered sampling with pre-programmed offset times makes test preparation easier. Rapid

sampling requires just two minutes per cell.

Carryover prevention is excellent. Typically as little as 200  $\mu\text{L}$  is needed for rinsing, and custom wash protocols allow the analyst to clean the probe with one or more solvents at once or with air.

### Programming Versatility

The RDS is designed to provide a broad range of programming capabilities to the analyst, including rapid setup of diffusion test parameters; configurable instructions to operators; sampling, wash, and rinse configurable on a cell-per-cell basis; speed and temperature changes during run; ability to add media to offset evaporation; ability to run different cell groups with different settings. The RDS platform supports Shimadzu, Waters, Agilent, and Thermo-Fisher trays, with a maximum drawer capacity of 108 vials (when using two trays).

# PHOENIX RDS AUTOMATED DIFFUSION TESTING

## Diffusion Master and 21 CFR Part 11 Compliance

Teledyne Hanson's Diffusion Master software provides speed, security, and scalability in an easy-to-use interface. Features include an unlimited number of users and groups; configurable permissions; password options; inactivity timeout; complete audit trail; serial number tracking; signatures for digitized and archived test reports; logs for events, errors, and test reports; searching and filtering on any number of database parameters; on-screen test progress and sample time alerts; system status and test reports output to network printer.

## Diffusion Master Workstation Requirements

Minimum requirements when server and client are running on the same PC are as follows:

- Operating system: Windows 10.
- If the server is on a different system, it can be Windows Server 2016 or newer.
- Newer versions of SQL Server require x64 CPU.
- Processor: Pentium 4 and compatible, or faster; x32 or x64; 2 cores minimum; 1.4 GHz minimum; 2 GHz or more recommended.
- Memory: 2 GB min.; 4 GB recommended.
- Storage: 20 GB free space recommended.
- One available USB port per each RDS system controlled by the workstation.

## Phoenix RDS Supply kit

Each Phoenix RDS system comes with start-up supplies including 14 evaporation caps, 14 stoppers, and one each of disposable syringe (20 mL), tweezers, dosage mixer, stainless steel lab spatula, bubble inspection mirror, and plastic o-ring tool.

## Phoenix RDS System Specifications

- Weight: 41.7 kg (92 lbs.) maximum (dry)
- Dimensions:
  - 62.9 cm W x 54.0 cm D x 50.8 cm H
- USP <1724> conformance:
  - Stirring speed:  $\pm 10\%$
  - Temperature:  $\pm 1.0\text{ }^{\circ}\text{C}$
- Heating block programmable from 25  $^{\circ}\text{C}$  to 46  $^{\circ}\text{C}$ .
- Power consumption: 300 watts max.
- Sample drawer capacity: 108 vials max.

## Phoenix RDS Wetted Materials

- Sampling probe: PEEK or stainless steel
- Liquid lines: PTFE tubing
- Syringe barrel: Borosilicate glass
- Syringe plunger seal: PTFE
- Wash lines: Tygon
- Wash block: PVC

## ORDERING INFORMATION - PHOENIX RDS AUTOMATED SAMPLING PLATFORM

### PHOENIX RDS DIFFUSION TESTING SYSTEMS

- 59-201-201** Phoenix RDS Automated Diffusion System 115/230V
- Includes one heating/stirring block, two spare sample probes (PEEK), two spare sample probes (316 SS), and supply kit. Order cells, mixers, cap kits, and additional heating/stirring blocks separately.
- 59-209-001** Diffusion Master Software (Required)
- 59-207-010** Diffusion Block Assembly (Field Install)
- 59-207-011** Diffusion Block Assembly (Factory Install)

### ACCESSORIES

- 59-207-163** Sample Probe Kit, PEEK
- 59-207-184** Sample Probe Kit, 316 SS
- 61-107-003** Evaporation Caps, 16 mm Reusable, Short Style (100/pk)
- 91-030-150** Vials w/pre-cut Septum, HPLC/UPLC, 12 mm X 32 mm (100/box)
- 91-030-159** Vial Tray, Waters, PHXRDS
- 91-030-161** Vial Tray, Shimadzu, PHXRDS
- 59-207-025** Tray Plate, Waters, PHXRDS (Special Order)
- 59-207-026** Tray Plate, Thermo-Fisher, PHXRDS (Special Order)

### Q-PAK™ QUALIFICATION GUIDELINES

- 59-208-210** Q-Pak for Phoenix RDS

# PHOENIX DRY HEAT SYSTEMS

## Phoenix Diffusion Cell Design

The most critical aspect of any lab testing instrument is its ability to produce results that are accurate (true) and precise (consistent from one test to the next). Variability—the enemy of precision—comes from inconsistencies in the test instrument itself, the test procedure, and the materials being tested. With these factors



*Small cell with tall mixer-insert provides 10 mL receptor media volume.*

*Large cell with short mixer-insert provides 31 mL receptor media volume.*

in mind, the Phoenix dry heat diffusion cell is designed to eliminate instrument variability while significantly reducing the potential for procedural inconsistencies (operator error). By incorporating improvements based on Hanson's 30 years of experience in manual and automated diffusion



*Slotted caps prevent loss of media while allowing manual sampling by pipette or autosampling by probe.*

cell systems, the new Phoenix cell is more durable and easier to operate while providing significantly better test results.

Constructed of precision-bore tubing such as found in barrel syringes, each borosilicate glass cell is dimensionally consistent with the next. The generous 9 mm internal diameter of the sampling arm promotes rapid homogenization of receptor media and allows the use of standard pipette tips to save on costs. Standard 16 mm evaporation caps fit onto the flanged end of the sampling arm.

- Phoenix cells are durable, portable, quick to assemble, and easy to clean.
- Three different styles of cell cap kits are designed to work interchangeably with each cell.



*Meniscus through center of fill mark conveniently indicates receptor media has reached the level of the membrane.*

## Receptor Media Volume Adjustment

Phoenix diffusion cells allow the analyst to adjust receptor media volume simply by changing the mixer-insert. The use of the short mixer-insert (13 mm height) provides the maximum available volume for a particular cell size. The tall mixer-insert (30 mm height) provides a lesser volume while still allowing samples to be taken from the center of the main body of the cell as specified in USP <1724> Semisolid Drug Products—Performance Tests.



# PHOENIX DIFFUSION CELLS

## Diffusion Cell Receptor Media Volumes, Nominal\*, with Mixer-Inserts Installed

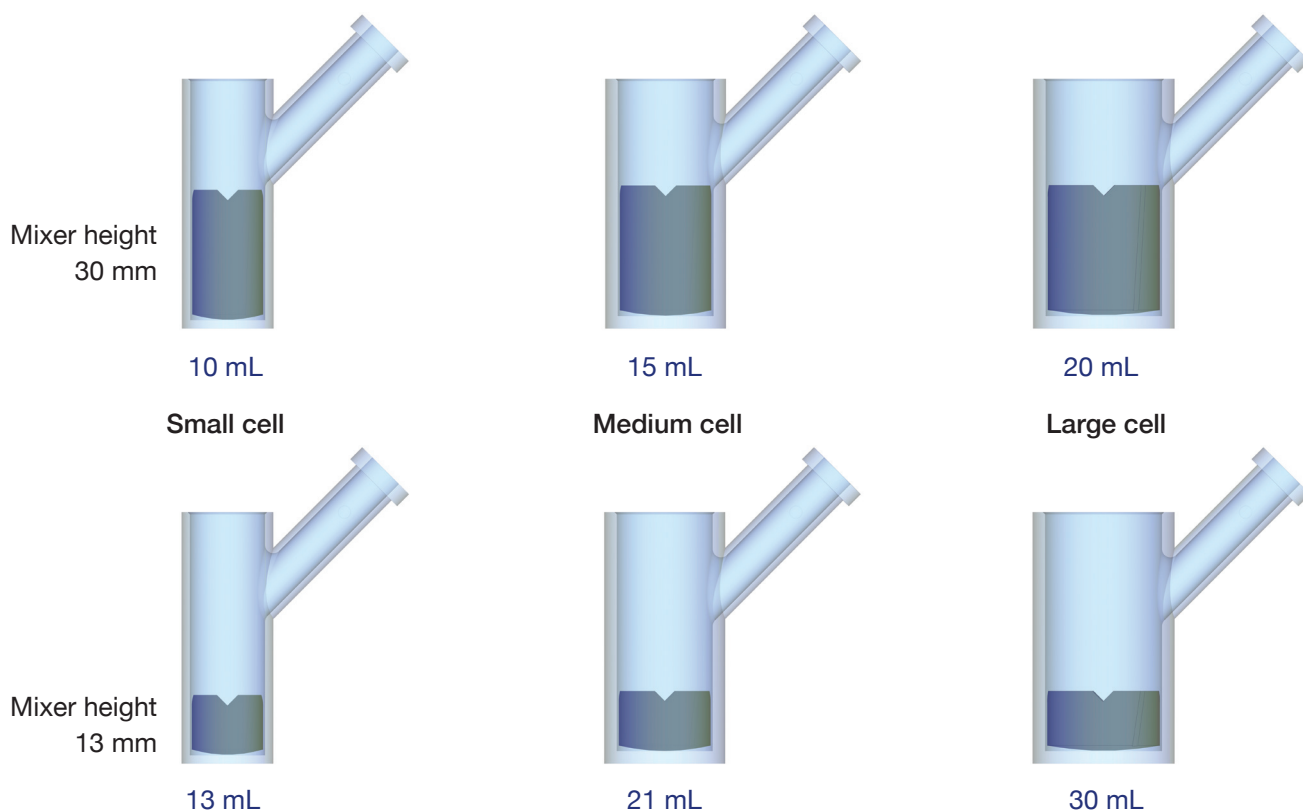

\* Volumes shown are nominal; actual volumes will vary and are determined by measurement of each specific diffusion cell assembly in the lab.

## Heat Transfer Sleeves Required for Small and Medium Cells

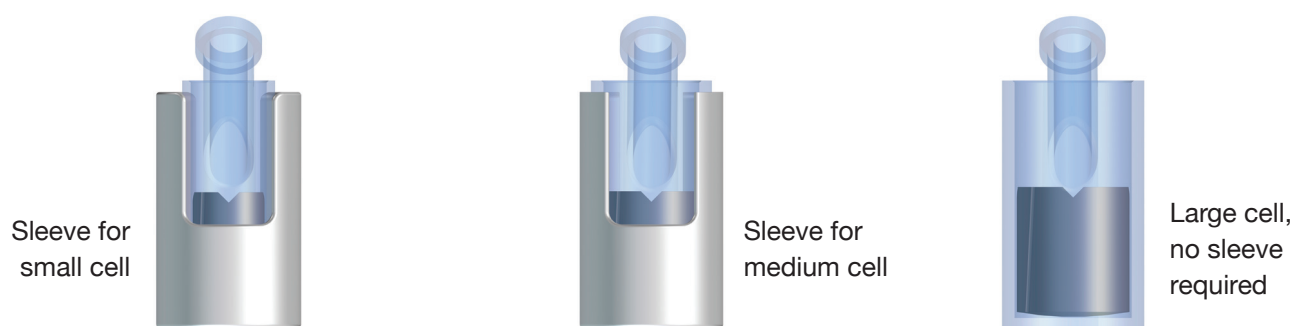

## ORDERING INFORMATION - DIFFUSION CELLS AND SLEEVES

### PHOENIX DIFFUSION CELLS, SERIALIZED

- 59-207-051** Cell, Small, Clear, PHX
- 59-207-061** Cell, Small, Amber, PHX
- 59-207-052** Cell, Medium, Clear, PHX
- 59-207-062** Cell, Medium, Amber, PHX
- 59-207-053** Cell, Large, Clear, PHX
- 59-207-063** Cell, Large, Amber, PHX

### CELL SLEEVES - BLACK ANODIZED ALUMINUM (1 REQUIRED FOR EACH SMALL/MEDIUM CELL)

- 59-207-022** Cell Sleeve, Medium, PHX
- 59-207-023** Cell Sleeve, Small, PHX

### EVAPORATION CAPS

- 61-107-003** Evaporation Caps, 16 mm, Reusable, Short Style (100/pk)

# PHOENIX DRY HEAT SYSTEMS

## Phoenix Dry Heat Diffusion Cell Mixers

Continuous homogenization of diffusion cell contents is essential to the accuracy and repeatability of release-rate testing. In diffusion cell testing, molecules of active pharmaceutical ingredient (API) migrate from a region of higher concentration (the donor chamber above the membrane) to one of lower concentration (the

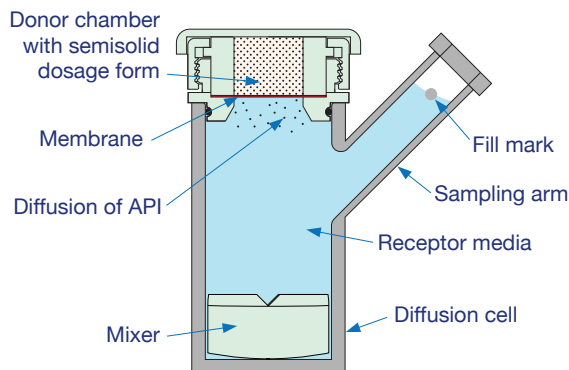

receptor media below the membrane). To prevent the formation of a region of high concentration just under the membrane—which would inhibit further release of API—molecules passing the membrane must be quickly dispersed throughout the receptor media.

In Phoenix systems the continuous dispersion of API is provided by grooved mixers rotating inside the diffusion cell, powered by six magnetic drives with brushless motors embedded in the

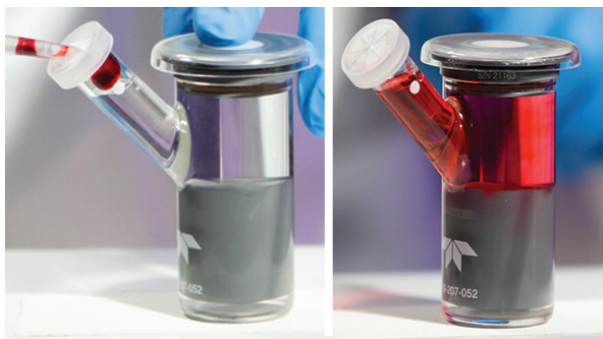

DB-6 heating/stirring block. The innovative mixers produce strong currents capable of reaching every part of the diffusion cell, including the entirety





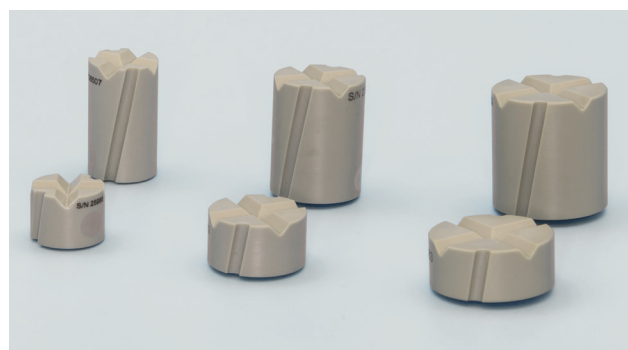

of the media in the sampling arm. Visual testing with red dye placed on the surface of the media at the top of the sampling arm shows complete dispersion occurs within a few seconds.

Further tests of mixing effectiveness on 27 groups of 6 cells each, running at a low speed (200 rpm), with Hydrocortisone cream analyzed by HPLC shows aliquots taken from the sampling arm and from the main body of the cell have the same level of concentration. For further details see “Apparatus Performance Report 99390008 Rev. 08-18 Phoenix Dry Heat Systems.”



The Phoenix mixer-insert also provides the analyst with the ability to use the same diffusion cell for two different receptor media volumes. Each cell size (small, medium, large) allows two different mixers with heights of 13 mm or 30 mm, thereby adjusting the amount of receptor media by volume displacement.

# PHOENIX CELL MIXER-INSERTS

ORDERING INFORMATION FOR PEEK AND PTFE MIXER-INSERTS					
Cell Size	Mixer Height (mm)	Cell Volume* (mL)	Mixer Material	Part Number and Description	
For Small Cells		13	13	PEEK	59-207-122 Mixer, Small, 13 mm, PEEK
				PTFE	59-207-140 Mixer, Small, 13 mm, PTFE
		30	10	PEEK	59-207-123 Mixer, Small, 30 mm, PEEK
				PTFE	59-207-141 Mixer, Small, 30 mm, PTFE
For Medium Cells		13	21	PEEK	59-207-126 Mixer, Medium, 13 mm, PEEK
				PTFE	59-207-143 Mixer, Medium, 13 mm, PTFE
		30	15	PEEK	59-207-127 Mixer, Medium, 30 mm, PEEK
				PTFE	59-207-144 Mixer, Medium, 30 mm, PTFE
For Large Cells		13	30	PEEK	59-207-130 Mixer, Large, 13 mm, PEEK
				PTFE	59-207-146 Mixer, Large, 13 mm, PTFE
		30	20	PEEK	59-207-131 Mixer, Large, 30 mm, PEEK
				PTFE	59-207-147 Mixer, Large, 30 mm, PTFE

\*Diffusion cell (receptor media) volume with mixer-insert installed. Volumes shown are nominal; actual volumes will vary and are determined by measurement of each specific diffusion cell assembly in the lab.

PEEK = Polyether ether ketone

PTFE = Polytetrafluoroethylene

# PHOENIX DRY HEAT SYSTEMS

## Cell Cap Kits

In diffusion cell testing, the active pharmaceutical ingredient (API) passes from the dosage chamber into the receptor medium in an amount proportional to the exposed area of the membrane, as determined by the orifice diameter. Phoenix cell cap kits are designed to provide analysts with precise control over this critical factor. In each cell cap kit, the orifices of the dosage chamber above the membrane and the cell cap below the membrane are machined to tight tolerances for diameter and concentricity.

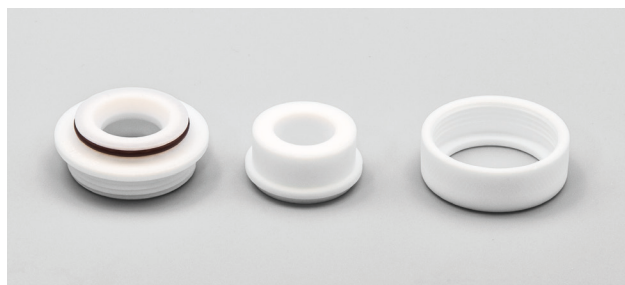

*Threaded cell cap kit serialized components include cell cap, dosage chamber, and clamp ring.*

Two orifice diameter sizes are available for each small, medium, or large cell. Depending on the cell size and the cap kit selected, orifice diameters range from 9 mm (membrane exposed area 64 mm<sup>2</sup>) to 20 mm (membrane exposed area 314 mm<sup>2</sup>). The diameter and height of the dosage chamber above the membrane determines the maximum amount of drug that may be tested. When a greater amount of the formulation is required for a test, select a cap kit with a larger dosage chamber.

### Threaded Versus Press-on Style of Cap Kit

Two general styles of cap kit are available—threaded and press-on. The threaded style of cap kit includes a threaded clamp ring above the dosage chamber, which allows an adjustable amount of force to be applied to hold the membrane in place. This feature is useful in applications where skin and other membrane types may shrink, swell, or otherwise deform during testing. Threaded cap kits are made from PTFE

(polytetrafluoroethylene), sealed with O-rings made from either fluoroelastomer (Viton) or perfluoroelastomer (Kalrez).

The press-on style of cap kit is held in place by the friction of the O-ring seals alone. The press-on style is faster to assemble and disassemble. The

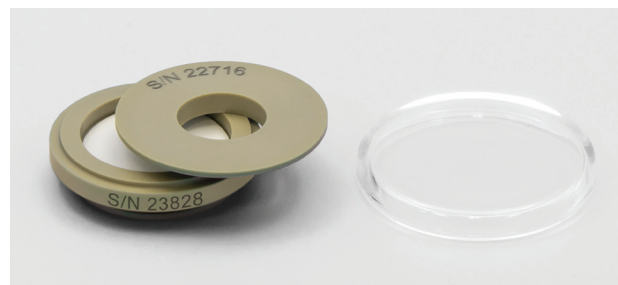

*Press-on cap kit includes serialized cell cap, serialized dosage chamber, and dosage cover.*

press-on cap kit for general applications provides a choice of two different dosage chamber heights (4 mm or 20 mm) for each orifice size. The press-on cap kit for skin applications has only one dosage chamber height (7 mm) and one orifice diameter for each cell size. In applications where a smaller membrane is needed, the cap kit for skin applications—when using the small cell size—allows a membrane diameter of 16 mm.

Press-on cap kits are made from PEEK (polyether ether ketone), sealed with fluoroelastomer (Viton) O-rings.

# THREADED CAP KITS

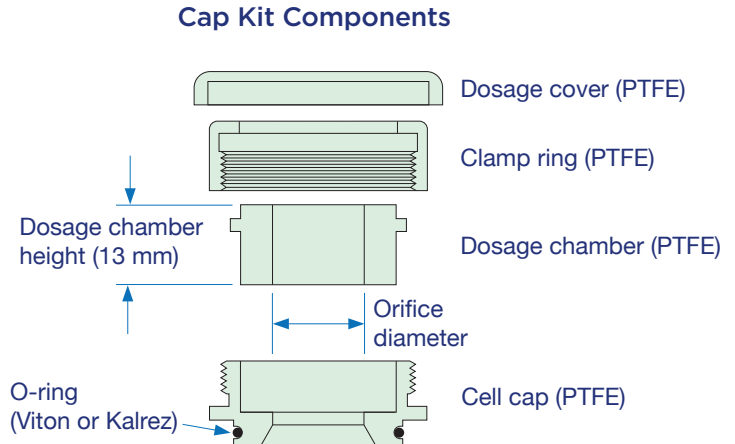
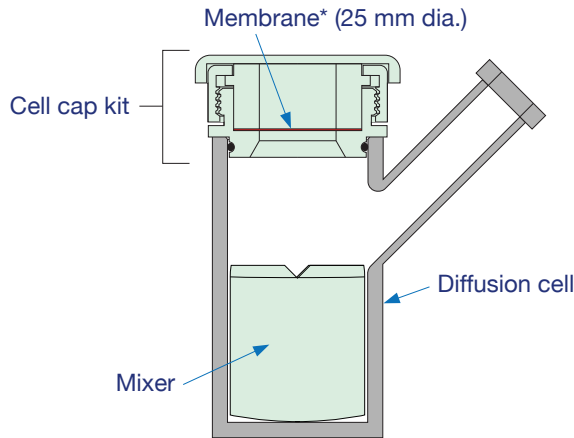

Threaded Cap Kits						
Cell Size	Orifice Diameter (mm)	Membrane Exposed Area (mm <sup>2</sup> )	Dosage Chamber Height (mm)	Maximum Dosage Volume (mL)	O-Ring Material	Cell Cap Kit Part Number
Small	9	64	13	0.8	Viton	59-207-210
	9			0.8	Kalrez	59-207-212
	11.3	100		1.3	Viton	59-207-211
	11.3			1.3	Kalrez	59-207-213
Medium	11.3	100		1.3	Viton	59-207-225
	11.3			1.3	Kalrez	59-207-227
	15	177		2.3	Viton	59-207-226
	15			2.3	Kalrez	59-207-228
Large	15	177		2.3	Viton	59-207-240
	15			2.3	Kalrez	59-207-242
	20	314		4.1	Viton	59-207-241
	20			4.1	Kalrez	59-207-243

All dimensions and volumes are nominal. Maximum dosage volume is based on dosage chamber filled to capacity.

\*Membrane sold separately. Threaded caps accommodate 25 mm dia. membranes with thickness 0.1 mm to 3.0 mm.

PTFE = Polytetrafluoroethylene

## ORDERING INFORMATION - THREADED CAP KITS, SERIALIZED (1 PER CELL)

### FOR SMALL CELLS

- 59-207-210** Threaded Cap Kit, Small, 9 mm, PTFE/Viton
- 59-207-211** Threaded Cap Kit, Small, 11.3 mm, PTFE/Viton
- 59-207-212** Threaded Cap Kit, Small, 9 mm, PTFE/Kalrez
- 59-207-213** Threaded Cap Kit, Small, 11.3 mm, PTFE/Kalrez

### FOR MEDIUM CELLS

- 59-207-225** Threaded Cap Kit, Medium, 11.3 mm, PTFE/Viton
- 59-207-226** Threaded Cap Kit, Medium, 15 mm, PTFE/Viton
- 59-207-227** Threaded Cap Kit, Medium, 11.3 mm, PTFE/Kalrez
- 59-207-228** Threaded Cap Kit, Medium, 15 mm, PTFE/Kalrez

### FOR LARGE CELLS

- 59-207-240** Threaded Cap Kit, Large, 15 mm, PTFE/Viton
- 59-207-241** Threaded Cap Kit, Large, 20 mm, PTFE/Viton
- 59-207-242** Threaded Cap Kit, Large, 15 mm, PTFE/Kalrez
- 59-207-243** Threaded Cap Kit, Large, 20 mm, PTFE/Kalrez

# PRESS-ON CAP KITS—GENERAL APPLICATIONS

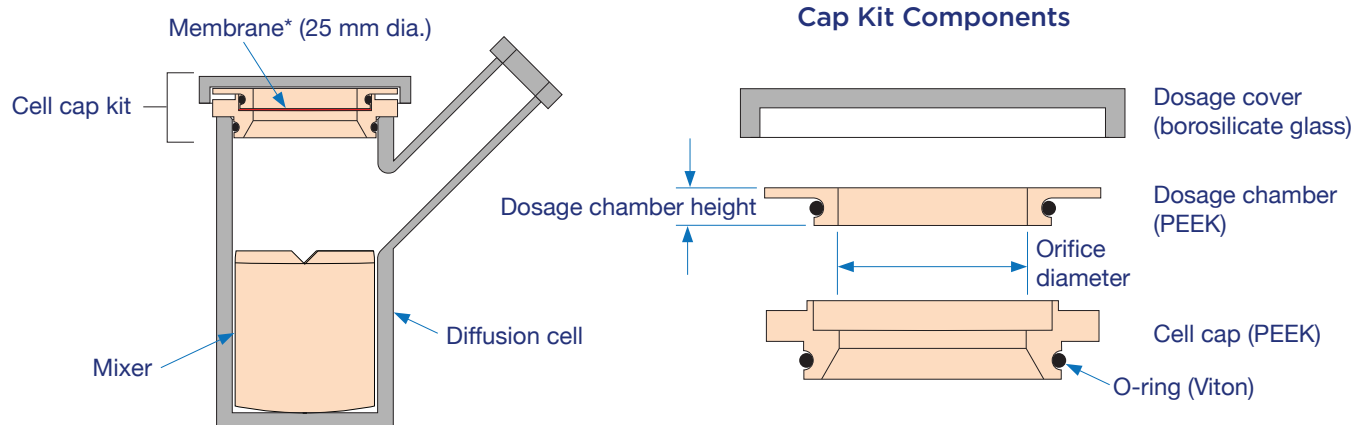

Press-on Cap Kits—General Applications					
Cell Size	Orifice Diameter (mm)	Membrane Exposed Area (mm <sup>2</sup> )	Dosage Chamber Height (mm)	Maximum Dosage Volume (mL)	Cell Cap Kit Part Number
Small	9	64	4	0.25	59-207-201
			20	1.3	59-207-202
	11.3	100	4	0.40	59-207-203
			20	2.0	59-207-204
Medium	11.3	100	4	0.40	59-207-215
			20	2.0	59-207-216
	15	177	4	0.71	59-207-217
			20	3.5	59-207-218
Large	15	177	4	0.71	59-207-231
			20	3.5	59-207-232
	20	314	4	1.26	59-207-233
			20	6.3	59-207-234

All dimensions and volumes are nominal. Maximum dosage volume is based on dosage chamber filled to capacity.

\*Membrane sold separately. Cell caps accommodate 25 mm diameter membranes with thickness 0.1 mm to 1.0 mm.

PEEK = Polyether ether ketone

## ORDERING INFORMATION - PRESS-ON CAP KITS, SERIALIZED (1 PER CELL)

### FOR SMALL CELLS

- 59-207-201** Press-on Cap Kit, Small, 9 mm X 4 mm, PEEK
- 59-207-202** Press-on Cap Kit, Small, 9 mm X 20 mm, PEEK
- 59-207-203** Press-on Cap Kit, Small, 11.3 mm X 4 mm, PEEK
- 59-207-204** Press-on Cap Kit, Small, 11.3 mm X 20 mm, PEEK

### FOR MEDIUM CELLS

- 59-207-215** Press-on Cap Kit, Medium, 11.3 mm X 4 mm, PEEK
- 59-207-216** Press-on Cap Kit, Medium, 11.3 mm X 20 mm, PEEK
- 59-207-217** Press-on Cap Kit, Medium, 15 mm X 4 mm, PEEK
- 59-207-218** Press-on Cap Kit, Medium, 15 mm X 20 mm, PEEK

### FOR LARGE CELLS

- 59-207-231** Press-on Cap Kit, Large, 15 mm X 4 mm, PEEK
- 59-207-232** Press-on Cap Kit, Large, 15 mm X 20 mm, PEEK
- 59-207-233** Press-on Cap Kit, Large, 20 mm X 4 mm, PEEK
- 59-207-234** Press-on Cap Kit, Large, 20 mm X 20 mm, PEEK

# PRESS-ON CAP KITS—SKIN APPLICATIONS

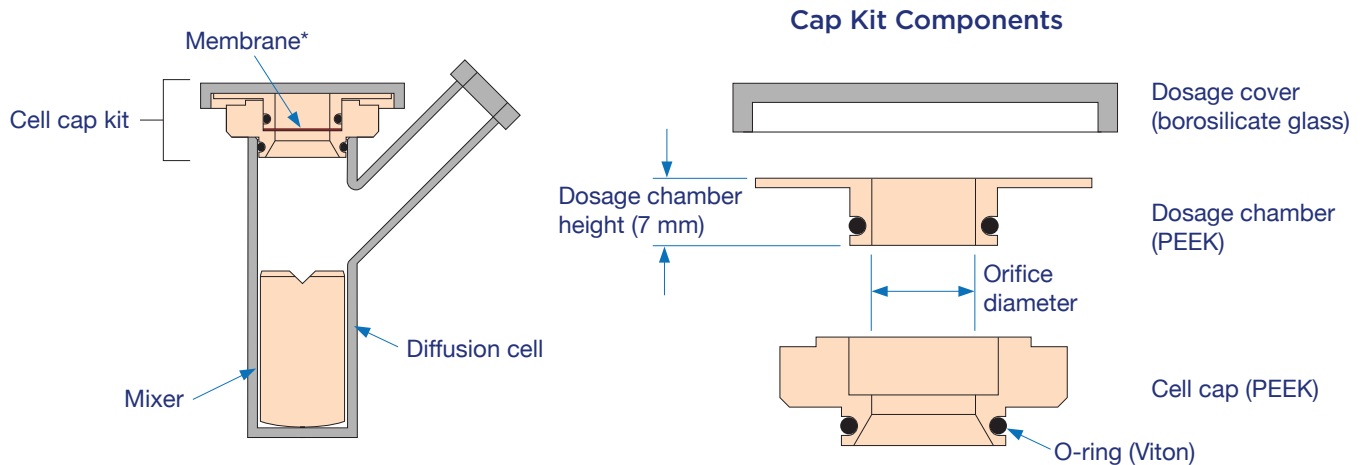

Press-on Cap Kits—Skin Applications							
Cell Size	Membrane Diameter (mm)	Orifice Diameter (mm)	Membrane Exposed Area (mm <sup>2</sup> )	Dosage Chamber Height (mm)	Maximum Dosage Volume (mL)	O-ring Material	Cell Cap Kit Part Number
Small	16	11.3	100	7	0.7	Viton	59-207-205
Medium	25	15	177		1.2		59-207-221
Large	25	20	314		2.2		59-207-235

All dimensions and volumes are nominal. Maximum dosage volume is based on dosage chamber filled to capacity.

\*Membrane not included. Cell caps accommodate membranes with thickness 0.1 mm to 3.0 mm.

PEEK = Polyether ether ketone

## APPLICATION NOTES

The small cell for skin applications is designed to accommodate testing with smaller membranes (16 mm as opposed to 25 mm diameter). In all cases the 7 mm deep dosage chamber allows skin or synthetic membranes up to 3.0 mm thick.

## ORDERING INFORMATION - PRESS-ON CAP KITS, SKIN, SERIALIZED (1 PER CELL)

### FOR SMALL CELLS

**59-207-205** Press-on Cap Kit, Skin, Small, 11.3 mm, PEEK

### FOR MEDIUM CELLS

**59-207-221** Press-on Cap Kit, Skin, Medium, 15 mm, PEEK

### FOR LARGE CELLS

**59-207-235** Press-on Cap Kit, Skin, Large, 20 mm, PEEK

# DIFFUSION CELL TESTING ACCESSORIES AND SUPPORT

## Method Development and Testing Services

Teledyne Hanson's Analytical Research Center (ARC), provides analytical lab services in support of pharmaceutical R&D, manufacturing, quality control, and regulatory compliance. The ARC—located in Chestnut Ridge, NY—leverages Hanson's



Diffusion testing at Analytic Research Center with Phoenix™ DB-6 manual sampling system.

decades of experience and innovation in the fields of dissolution, diffusion, and disintegration testing. ARC services in support of diffusion cell testing include method development and transfer; release rate testing of semisolid formulations for product development, batch release, and stability; out of spec (OOS) results investigations; and cleaning procedures for manufacturing equipment.

## Teledyne Technologies and Hanson Research

Teledyne Technologies (NYSE:TDY) is devoted to advancing science, acquiring and inventing new technology, and using it to help our customers solve challenges in business and society. Teledyne Hanson, a division of Teledyne Instruments, Inc., specializes in the design and manufacture of analytical test instruments for the pharmaceutical industry. Teledyne Hanson instruments are used by scientists in over 75 countries worldwide and are supported by the industry's top customer service team. For additional information please visit [www.teledynehanson.com](http://www.teledynehanson.com).

## Diffusion Cell Transport and Storage Accessories

The cell transport accessory helps protect a set of six diffusion cells during transport within the lab, such as between testing and cleaning stations.



**59-207-041** Cell Transport, Small

**59-207-042** Cell Transport, Medium

**59-207-043** Cell Transport, Large

Specifications (all sizes): Material ABS, 0.3 kg,  
36 cm x 11 cm x 5.5 cm

The heavy duty, water-tight storage case keeps serialized diffusion cells and their related serialized mixers and cell cap kits together in six compartments, one for each testing position.



**59-207-045** Diffusion Cell Storage Case

Specifications: Material polypropylene, 2.1 kg,  
36 cm x 23 cm x 7.5 cm

## Instrument Qualification and Maintenance

Teledyne Hanson offers service and support options for the Phoenix DB-6 and RDS systems, including Installation Qualification (IQ), Operation Qualification (OQ), Performance Qualification (PQ), and Preventive Maintenance (PM) plans. Consult your local representative for details.